



# FITTINGS



# 7 Fittings

## 7.1 Standard-Fittings

### SOCKET

#### TECHNICAL DATA

**DESCRIPTION** socket, for heating element socket welding, for connecting pipes or capillary tube mats/heating and cooling mats

**Ø INSIDE** 20 to 63 mm

**MATERIAL/COLOUR** PP-R/blue

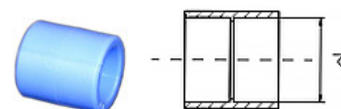

ITEM NO.	ADD-ON NO.	D	PU [PC.]
<b>800</b>	. 2000	20	1
	. 2500	25	1
	. 3200	32	1
	. 4000	40	1
	. 5000	50	1
	. 6300	63	1

### REDUCING PIECE (I-O)

#### TECHNICAL DATA

**DESCRIPTION** reducing piece inside/outside, for heating element socket welding, for connecting pipes or capillary tube mats/heating and cooling mats

**Ø OUTSIDE D1** 25 to 63 mm

**Ø INSIDE D2** 20 to 50 mm

**MATERIAL/COLOUR** PP-R/blue

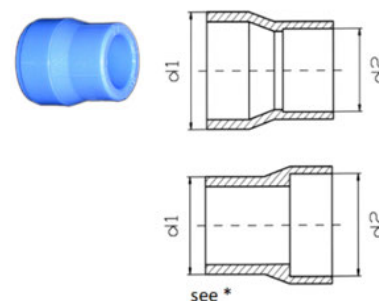

ITEM NO.	ADD-ON NO.	D1	D2	PU [PC.]
<b>802</b>	. 2502	25 *	20	1
	. 3201	32	20	1
	. 3202	32 *	25	1
	. 4001	40	20	1
	. 4002	40	25	1
	. 4003	40 *	32	1
	. 5001	50	20	1
	. 5002	50	25	1
	. 5003	50	32	1
	. 5004	50 *	40	1
	. 6301	63	25	1
	. 6302	63	32	1
	. 6303	63	40	1
	. 6304	63 *	50	1

## TRANSITION PIECE WITH EXTERNAL HEXAGONAL BOLT

### TECHNICAL DATA

<b>DESCRIPTION</b>	transition piece with male thread and hex head, for heating element socket welding
<b>Ø INSIDE</b>	20 to 63 mm
<b>THREAD</b>	1/2 to 2" male thread
<b>MATERIAL/COLOUR</b>	transition piece: PP-R/blue, thread/hex head: brass

ITEM NO.	ADD-ON NO.	D	MALE THREAD	PU [PC.]
<b>810</b>	. 2001	20	1/2"	1
* subject to availability	. 2002 *	20	3/4"	1
	. 2501	25	3/4"	1
	. 3201	32	3/4"	1
	. 3202	32	1"	1
	. 4001	40	1"	1
	. 4002	40	1 1/4"	1
	. 5001	50	1 1/4"	1
	. 5002	50	1 1/2"	1
	. 6301	63	1 1/2"	1

## TRANSITION COUPLING WITHOUT EXTERNAL HEXAGONAL

### TECHNICAL DATA

<b>DESCRIPTION</b>	transition coupling, round, with male thread, without hex head, for heating element socket welding
<b>Ø INSIDE</b>	16 to 25 mm
<b>THREAD</b>	1/2 to 3/4" male thread
<b>MATERIAL/COLOUR</b>	transition coupling: PP-R/blue, thread: brass



ITEM NO.	ADD-ON NO.	D	MALE THREAD	PU [PC.]
<b>811</b>	. 2001	20	1/2"	1
* subject to availability	. 2002 *	20	3/4"	1
	. 2501	25	1/2"	1
	. 2502	25	3/4"	1

## TRANSITION SLEEVE

### TECHNICAL DATA

<b>DESCRIPTION</b>	transition sleeve with female thread, with hex head, for heating element socket welding
<b>Ø INSIDE</b>	20 to 63 mm
<b>THREAD</b>	1/2 to 2" female thread
<b>MATERIAL/COLOUR</b>	transition sleeve: PP-R/blue, thread/hex head: brass



ITEM NO.	ADD-ON NO.	D	FEMALE THREAD	PU [PC.]
<b>816</b>	. 2001	20	½"	1
* subject to availability	. 2002 *	20	¾"	1
	. 2501	25	¾"	1
	. 3201	32	¾"	1
	. 3202	32	1"	1
	. 4001	40	1"	1
	. 4002	40	1¼"	1
	. 5001	50	1½"	1
	. 6301	63	1½"	1

## TRANSITION SOCKET

### TECHNICAL DATA

<b>DESCRIPTION</b>	transition socket, round, with female thread, without hex head, for heating element socket welding
<b>Ø INSIDE</b>	20 to 25 mm
<b>THREAD</b>	1/2 to 3/4" IG
<b>MATERIAL/COLOUR</b>	transition socket: PP-R/blue, thread: brass



ITEM NO.	ADD-ON NO.	D	FEMALE THREAD	PU [PC.]
<b>817</b>	. 2001	20	½"	1
* subject to availability	. 2002 *	20	¾"	1
	. 2501	25	½"	1
	. 2502	25	¾"	1

## 90° ELBOW (I-I)

### TECHNICAL DATA

<b>DESCRIPTION</b>	90° elbow female/female, for heating element socket welding
<b>Ø INSIDE</b>	20 to 63 mm
<b>MATERIAL/COLOUR</b>	PP-R/blue



ITEM NO.	ADD-ON NO.	D	PU [PC.]
<b>820</b>	. 2000	20	1
	. 2500	25	1
	. 3200	32	1
	. 4000	40	1
	. 5000	50	1
	. 6300	63	1

## 90° TRANSITION ELBOW MALE THREAD

### TECHNICAL DATA

<b>DESCRIPTION</b>	90° transition elbow with male thread, from 1" with hex head, for heating element socket welding
<b>Ø INSIDE</b>	20 to 32 mm
<b>THREAD</b>	1/2 to 1" male thread
<b>MATERIAL/COLOUR</b>	transition elbow: PP-R/blue, thread/hex head: brass



ITEM NO.	ADD-ON NO.	D	MALE THREAD	PU [PC.]
<b>821</b>	. 2001	20	1/2"	1
* subject to availability	. 2002 *	20	3/4"	1
	. 2501	25	1/2"	1
	. 2502	25	3/4"	1
** discontinued article	. 3201 **	32	3/4"	1

## 90° TRANSITION ELBOW FEMALE THREAD

### TECHNICAL DATA

<b>DESCRIPTION</b>	90° transition elbow with female thread, from 1" with hex head, for heating element socket welding
<b>Ø INSIDE</b>	20 to 32 mm
<b>THREAD</b>	1/2 to 1" female thread
<b>MATERIAL/COLOUR</b>	transition elbow: PP-R/blue, thread/hex head: brass

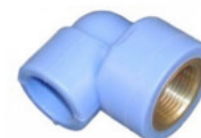

ITEM NO.	ADD-ON NO.	D	FEMALE THREAD	PU [PC.]
<b>822</b>	. 2001	20	1/2"	1
* subject to availability	. 2002 *	20	3/4"	1
	. 2501	25	1/2"	1
	. 2502	25	3/4"	1
	. 3201	32	3/4"	1

## 45° ELBOW (I-I)

### TECHNICAL DATA

<b>DESCRIPTION</b>	45° elbow female/female, for heating element socket welding
<b>Ø INSIDE</b>	20 to 63 mm
<b>MATERIAL/COLOUR</b>	PP-R/blue



ITEM NO.	ADD-ON NO.	D	PU [PC.]
<b>823</b>	. 2000	20	1
	. 2500	25	1
	. 3200	32	1
	. 4000	40	1
	. 5000	50	1
	. 6300	63	1

## 45° ELBOW (I-O)

## TECHNICAL DATA

<b>DESCRIPTION</b>	45° elbow female/male, for heating element socket welding
<b>Ø INSIDE</b>	20 to 32 mm
<b>MATERIAL/COLOUR</b>	PP-R/blue



ITEM NO.	ADD-ON NO.	D	PU [PC.]
<b>824</b>	. 2000	20	1
	. 2500	25	1
	. 3200	32	1
** discontinued article	. 4000 **	40	1

## T-PIECE 90° EQUAL

## TECHNICAL DATA

<b>DESCRIPTION</b>	T-piece 90° equal, for heating element socket welding, for connecting pipes or capillary tube mats/heating and cooling mats
<b>Ø INSIDE</b>	20 to 63 mm
<b>MATERIAL/COLOUR</b>	PP-R/blue



ITEM NO.	ADD-ON NO.	D	PU [PC.]
<b>825</b>	. 2000	20	1
	. 2500	25	1
	. 3200	32	1
	. 4000	40	1
	. 5000	50	1
	. 6300	63	1

## 90° ELBOW (I-O)

## TECHNICAL DATA

<b>DESCRIPTION</b>	90° elbow female/male, for heating element socket welding
<b>Ø INSIDE</b>	20 to 40 mm
<b>MATERIAL/COLOUR</b>	PP-R/blue



ITEM NO.	ADD-ON NO.	D	PU [PC.]
<b>826</b>	. 2000	20	1
	. 2500	25	1
	. 3200	32	1
	. 4000	40	1

## T-PIECE 90° REDUCED

### TECHNICAL DATA

**DESCRIPTION** T-piece 90° reduced, for heating element socket welding

**Ø INSIDE D1** 25 to 63 mm

**Ø INSIDE D2** 20 to 50 mm

**Ø INSIDE D3** 25 to 63 mm

**MATERIAL/COLOUR** PP-R/blue



ITEM NO.	ADD-ON NO.	D1	D2	D3	PU [PC.]
<b>830</b>	.2502	25	20	20	1
	.2503	25	20	25	1
	.3201	32	20	32	1
	.3202	32	25	32	1
	.4001	40	20	40	1
	.4002	40	25	40	1
	.4003	40	32	40	1
	.5002	50	25	50	1
	.5003	50	32	50	1
	.5004	50	40	50	1
	.6302	63	25	63	1
	.6303	63	32	63	1
	.6304	63	40	63	1
	.6305	63	50	63	1

## THREADED BRANCH TEE

### TECHNICAL DATA

**DESCRIPTION** threaded branch tee 90° with female thread, from 1" with hex head, for heating element socket welding

**Ø INSIDE** 20 to 40 mm

**THREAD** 1/2 to 1" female thread

**MATERIAL/COLOUR** branch tee: PP-R/blue, thread/hex head: brass

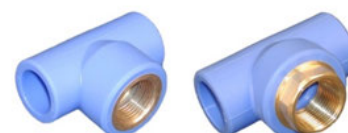

ITEM NO.	ADD-ON NO.	D1	FEMALE THREAD	PU [PC.]
<b>832</b>	.2001	20	1/2"	1
* subject to availability	.2002 *	20	3/4"	1
	.2501	25	1/2"	1
	.2502	25	3/4"	1
	.3201	32	3/4"	1
	.3202	32	1"	1
	.4001	40	3/4"	1

## END CAP

### TECHNICAL DATA

<b>DESCRIPTION</b>	end cap, for heating element socket welding, for closing pipes or capillary tube mats/heating and cooling mats
<b>Ø INSIDE</b>	20 to 63 mm
<b>MATERIAL/COLOUR</b>	PP-R/blue

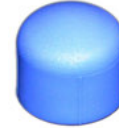

ITEM NO.	ADD-ON NO.	D	PU [PC.]
<b>845</b>	. 2000	20	1
	. 2500	25	1
	. 3200	32	1
	. 4000	40	1
	. 5000	50	1
	. 6300	63	1

## TRANSITION SCREW MALE

### TECHNICAL DATA

<b>DESCRIPTION</b>	transition screw with male thread and hex head, for heating element socket welding
<b>Ø</b>	20 to 63 mm
<b>THREAD</b>	1/2 to 2" male thread
<b>MATERIAL/COLOUR</b>	pipe end: PP-R/blue, thread/hex head: brass



ITEM NO.	ADD-ON NO.	D	MALE THREAD	PU [PC.]
<b>861</b>	. 2000	20	½"	1
	. 2500	25	¾"	1
	. 3200	32	1"	1
	. 4000	40	1¼"	1
	. 5000	50	1½"	1
	. 6300	63	2"	1

## PP-SOCKET BALL VALVE

### TECHNICAL DATA

<b>DESCRIPTION</b>	PP-socket ball valve, to shut off, for heating element socket welding
<b>Ø INSIDE</b>	20 to 63 mm
<b>MATERIAL/COLOUR</b>	PP-R/blue or green



ITEM NO.	ADD-ON NO.	D	L/H	PU [PC.]
<b>870</b>	. 2000	20	on request	1
	. 2500	25	on request	1
	. 3200	32	on request	1
	. 4000	40	on request	1
	. 5000	50	on request	1
	. 6300	63	on request	1



## 7.2 Special-Fittings

Clina Fittings are made of high-quality polypropylene (PP-R) like the capillary tube mats for heating and cooling. All fittings are DVGW - registered and standardised to DIN 16962.

### INSIDE SOCKET

#### TECHNICAL DATA

<b>DESCRIPTION</b>	inside socket for heating element inside socket welding
<b>ITEM NO.</b>	FI 20
<b>Ø OUTSIDE</b>	20 mm
<b>MATERIAL/COLOUR</b>	PP-R/blue

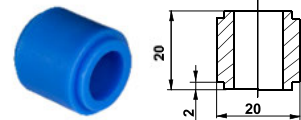

### 90° ELBOW WITH INSIDE SOCKET

#### TECHNICAL DATA

<b>DESCRIPTION</b>	90° elbow with inside socket for heating element inside socket welding
<b>ITEM NO.</b>	FWI 9020
<b>Ø OUTSIDE</b>	20 mm
<b>MATERIAL/COLOUR</b>	PP-R/blue

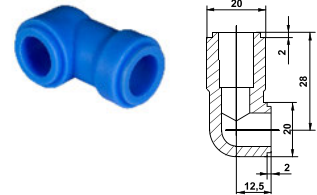

### 90° ELBOW HS

#### TECHNICAL DATA

<b>DESCRIPTION</b>	90° elbow for butt-welding
<b>ITEM NO.</b>	FWS 9020
<b>Ø OUTSIDE</b>	20 mm
<b>MATERIAL/COLOUR</b>	PP-R/blue



### END CAP WITH GRIP

#### TECHNICAL DATA

<b>DESCRIPTION</b>	end cap for butt welding, with grip, for closing pipes or capillary tube mats/heating and cooling mats
<b>ITEM NO.</b>	FESG 20
<b>Ø OUTSIDE</b>	20 mm
<b>MATERIAL/COLOUR</b>	PP-R/blue



**VALVE CONNECTION**

TECHNICAL DATA

<b>DESCRIPTION</b>	valve connection, socket end for heating element socket welding, 20 x 3/4 inside thread Euroconus
<b>ITEM NO.</b>	FVM 20
<b>Ø OUTSIDE</b>	20 mm
<b>MATERIAL/COLOUR/SURFACE</b>	socket end: PP-R/blue union nut (Überwurfmutter): nickel-plated brass

